

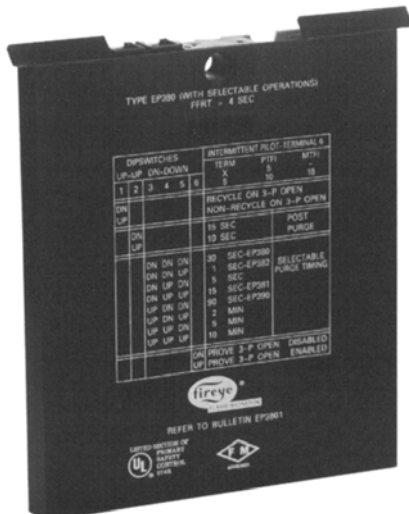

FIREYE® EP380, EP381, EP382, EP383, EP390 PROGRAMMER MODULES

WITH SELECTABLE OPERATION
FOR USE WITH THE
FIREYE® FLAME-MONITOR CONTROL



TYPE EP380 (WITH SELECTABLE OPERATIONS)
FIRT = 4 SEC

DIPSWITCHES						INTERMITTENT PLOT TERMINAL 6		
UP/DN						TERM 6	FIRT	6
1	2	3	4	5	6	5	10	15
UP	UP	UP	UP	UP	UP	RECYCLE ON 3-P OPEN	15 SEC	POST PURGE
DN	DN	DN	DN	DN	DN	NON-RECYCLE ON 3-P OPEN	19 SEC	
UP	UP	UP	UP	UP	UP	30 SEC-EP380	15 SEC	SELECTABLE PURGE TRNG.
DN	DN	DN	DN	DN	DN	1 SEC-EP380	3 SEC	
UP	UP	UP	UP	UP	UP	15 SEC-EP380	15 SEC	
DN	DN	DN	DN	DN	DN	30 SEC-EP380	30 SEC	
UP	UP	UP	UP	UP	UP	2 MIN	2 MIN	
DN	DN	DN	DN	DN	DN	5 MIN	5 MIN	
UP	UP	UP	UP	UP	UP	ON PROVE 3-P OPEN	DISABLED	
DN	DN	DN	DN	DN	DN	OFF PROVE 3-P OPEN	ENABLED	

fireye®
REFER TO BULLETIN EP381

UL LISTED
FM APPROVED



DESCRIPTION

The Fireye EP380, EP381, EP382, EP383, EP390 Programmer Modules are used with the FIREYE FLAME-MONITOR Burner Management Control System (P/N E110). Several operational characteristics are determined by six (6) dipswitches located on the side of the programmer. These characteristics include recycle or non-recycle operation when the running interlock circuit (3-P) is opened during the firing cycle (dipswitch 1), intermittent or interrupted operation of terminal 6 (dipswitch 2), extended purge timing, (dipswitches 3, 4, 5), and the option that requires the 3-P running interlock circuit to be proven open at the start of the operating cycle (dipswitch 6).

Model EP383 characteristics are programmed via the ED510 display module, rather than by dipswitch.

The EP380, EP381, EP382, EP383, and EP390 programmers provide start-up programming, safe-start check, and flame monitoring supervision. They insure proof of low fire position, and fuel valve end switch safety checks. The control is designed to initiate a safety lockout if any of these circuits are open at the improper point in the control cycle. A running interlock circuit on the Flame-Monitor system constantly monitors the limit switches, air flow switches, and fuel pressure switches through the programmer. A modulator (firing rate motor) circuit is not provided on these Programmer Modules.

The programmer module will de-energize all fuel valve circuits within four (4) seconds (max.) following a flame failure or at the end of the pilot trial for ignition period if no flame is detected. An alarm circuit will be energized following a safety lockout.

The programmer module includes an RJ45 style connector to interface with an integral or remote alpha-numeric display (P/N ED510). It is also backward compatible with the ED500¹ display. It includes two (2) additional RJ style connectors to connect to an E500 Communication Interface in a multi-drop configuration. The programmer will also communicate with the E500 via the standard ED550 cables to provide backward compatibility.

The programmer is the heart of the FLAME-MONITOR System and features a plug-in design for ease of installation. It is micro-processor based and stores the burner cycles, burner hours, system hours, and lockout history (with burner cycle and burner hour time stamp) which are accessible via the ED510 alpha-numeric display, E500 Communication Interface or Modbus communications. If replaced, the new programmer card will begin accumulating a new history.

Refer to Bulletin E-1101 for detailed information on the FLAME-MONITOR System.

¹ The ED500 display was the predecessor of the ED510 display. It does not have the latest features of the ED510 display module.



INSTALLATION



CAUTION: To prevent shock hazard, remove power from the system wiring base before proceeding. Remove control from the wiring base before proceeding.

The EP programmer modules are used with the Fireeye EB700 base chassis. They are installed in the chassis by inserting the EP programmer module into the second slot on the control. This slot is marked “Programmer Module” on the side of the chassis.

The programmer module is designed to fit only in the proper slot. It cannot be snapped into place if inserted in the wrong location. **DO NOT FORCE THEM.**

An amplifier module and flame scanner are also required for the FLAME-MONITOR control.

The EP380, EP381, EP382, EP393, and EP390 programmers with an Engineering code of 28 or later (e.g. 9414-28) are compatible with both the ED500 and ED510 display modules. See “Programmer and Display Module Compatibility” later in this document. The Engineering code is located on the back side of the board in the lower right hand corner. The EP383 programmer requires the ED510 display for initial configuration programming.

ORDERING INFORMATION

PART NUMBER	PURGE	IGNITION TIMING			POST PURGE	FFRT ²
			PTFI	MTFI		
EP380	30 sec. ¹	Term 5	10 sec.	10 sec.	15 sec.	4 sec.
		Term 6	10 sec.	15 sec. ⁴		
EP381	15 sec. ¹	Term 5	10 sec.	10 sec.	15 sec.	4 sec.
		Term 6	10 sec.	15 sec. ⁴		
EP382	1 sec. ¹	Term 5	10 sec.	10 sec.	10 sec. ⁵	4 sec.
		Term 6	10 sec.	15 sec. ⁴		
EP383	30 sec. ³	Term 5	15 sec. ³	10 sec.	15 sec. ³	4 sec. ³
		Term 6	15 sec. ³	15 sec. ^{3,4}		
EP390	90 sec. ¹	Term 5	10 sec.	10 sec.	15 Sec.	4 Sec.
		Term 6	10 sec.	15 sec. ⁴		

¹ Purge timings can be increased. See table on dipswitch functions.

² FFRT is the Flame Failure Response Time.

³ The EP383 purge, ignition, FFRT, and post-purge timings are programmable via ED510.

⁴ Intermittent / Interrupted operation may be selected via dipswitch (or via ED510 with EP383).

⁵ Programmer provides 15 second post-purge following a safety lockout.



WARNING: While all controls are mechanically interchangeable because they mate with a common wiring base, you must select the correct model for your application. Inappropriate application of a control could result in an unsafe condition hazardous to life and property.

APPROVALS

Underwriters Laboratories Inc.:

MCCZ File MP 1537 - Controls, Primary Safety - Listed
 MCCZ2 File MP1537 - Controls, Primary Safety - Component
 MCCZ7 File MP1537 - Controls, Primary Safety Certified for Canada
 MCCZ8 file MP1537 - Controls, Primary Safety Certified for Canada - Component

ACCEPTABLE BY: INDUSTRIAL RISK INSURERS (I.R.I.)

FACTORY MUTUAL (FM) APPROVED



WARNING: This equipment generates, uses and can radiate radio frequency energy, and, if not installed and used in accordance with the instruction manual, may cause interference to radio communications. It has been tested and found to comply with the limits for a Class A computing device pursuant to Subpart J of Part 15 of FCC Rules, which are designed to provide reasonable protection against such interference when operated in a commercial environment. Operation of this equipment in a residential area is likely to cause interference, in which case the user, at his own expense, will be required to take whatever measures may be required to correct the interference.

TIMING CHARTS

TYPE EP380

SELECTABLE OPERATION (RECYCLE OR NON-RECYCLE) RUNNING INTERLOCKS (3/P)
 PURGE TIME - 30 SEC.¹ FLAME FAILURE RESPONSE TIME 4 SEC.
 PROGRAMMING SEQUENCE

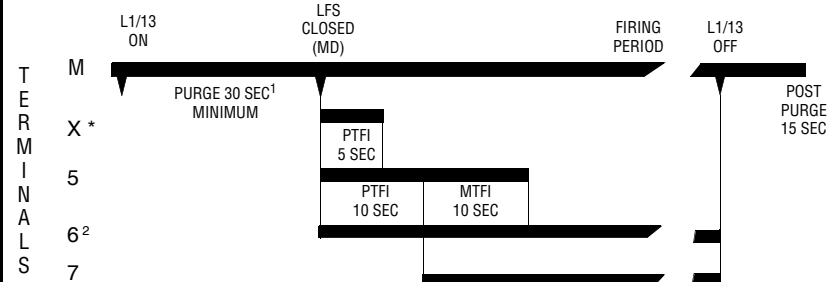

* TERMINAL "X" USAGE REQUIRES JUMPERING "5" & "10" ON THE WIRING BASE

DIPSWITCH SETTINGS

1	2	3	4	5	6
Down	Down	Down	Down	Down	Down

TYPE EP381

SELECTABLE OPERATION (RECYCLE OR NON-RECYCLE) RUNNING INTERLOCKS (3/P)
 PURGE TIME - 15 SEC.¹ FLAME FAILURE RESPONSE TIME 4 SEC.
 PROGRAMMING SEQUENCE

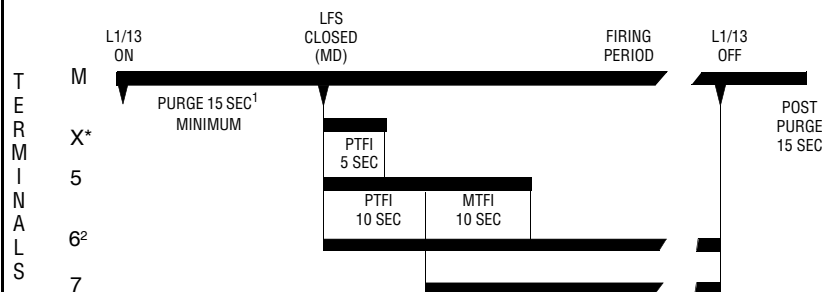

* TERMINAL "X" USAGE REQUIRES JUMPERING "5" & "10" ON THE WIRING BASE

DIPSWITCH SETTINGS

1	2	3	4	5	6
Down	Down	Down	Down	Down	Down

¹ Purge timings can be increased.

² When dipswitch 2 selects terminal 6 for interrupted operation, terminal 6 is energized for 10 seconds during PTFI and 15 seconds during MTFI.

³ Programmer provides 15 second post-purge following a safety lockout.

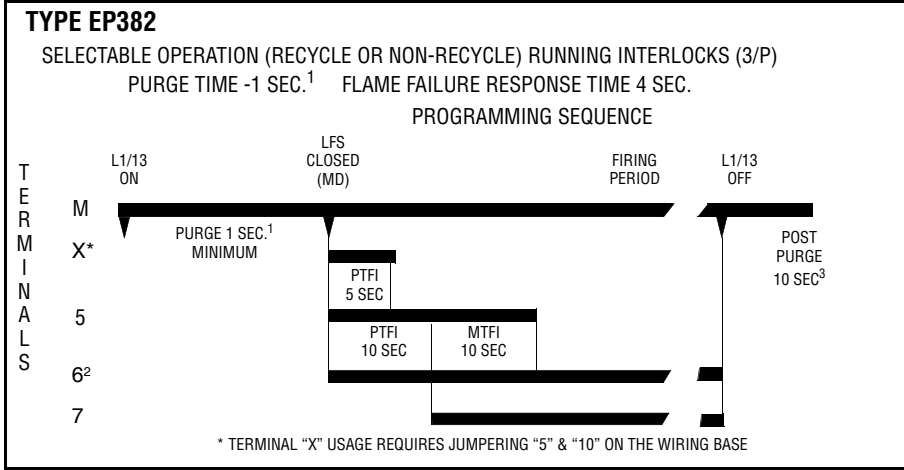

DIPSWITCH SETTINGS

1	2	3	4	5	6
Down	Down	Down	Down	Down	Down

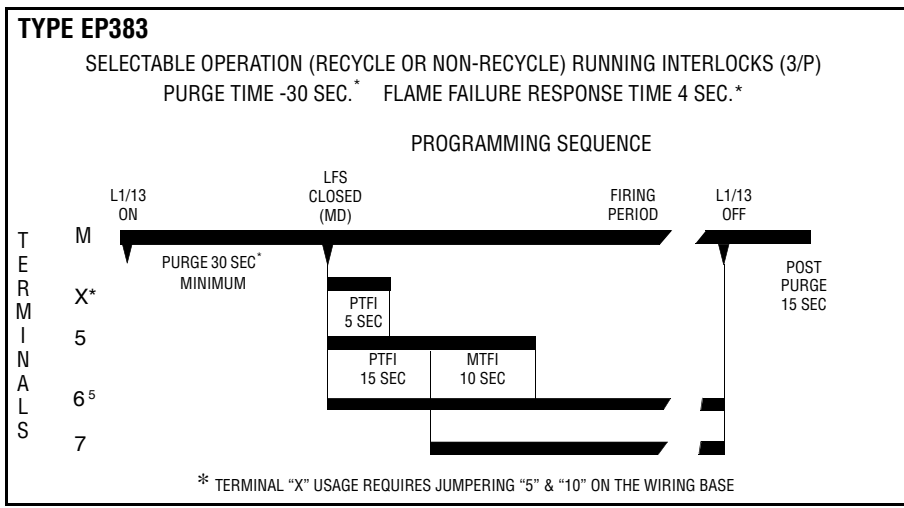

DIPSWITCH SETTINGS

1	2	3	4	5	6
ALL SETTINGS ARE INACTIVE					

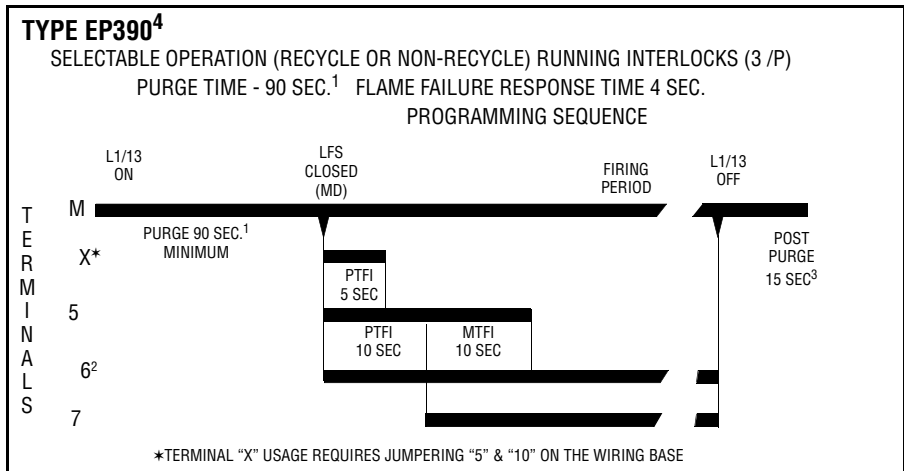

DIPSWITCH SETTINGS

1	2	3	4	5	6
Down	Down	Down	Down	Down	Down

- 1 Purge timings can be increased.
- 2 When dipswitch 2 selects terminal 6 for interrupted operation (except models EP383, EP390, EP390WR, EP390WN), terminal 6 is energized for 10 seconds during PTFI and 15 seconds during MTFI.
- 3 Programmer provides 15 second post-purge following a safety lockout.
- 4 The EP383 may be programmed for 15 second interrupted operation via EP510 display.

NOTE: All Programmars have a 2 second safe start check before initiating purge.

DIPSWITCHES FOR SELECTABLE OPERATION:

The operational characteristics of the EP380, EP381, EP382, and EP390 programmer modules are determined by six (6) dipswitches located on the side of the programmer. These characteristics include recycle or non-recycle operation when the running interlock circuit (3-P) is opened during the firing cycle, intermittent or interrupted operation of terminal 6, extended purge timing, and the option that requires the 3-P running interlock circuit to be proven open at the start of the operating cycle.



WARNING: THE INAPPROPRIATE SELECTION OR APPLICATION OF A PROGRAMMER MODULE COULD RESULT IN AN UNSAFE CONDITION HAZARDOUS TO LIFE AND PROPERTY. The various programmer modules (EP160, EP260, and EP380) are interchangeable because they plug into a common chassis. Changing the dipswitches modifies the operation of each programmer module. Care must be taken to insure the proper dipswitch settings. Selection of the programmer module and setting the dipswitches for a particular application should be made by a competent professional, such as a Boiler/Burner technician licensed by a state or other government agency, engineering personnel of the burner, boiler, or furnace manufacturer (OEM) or in performance of duties based on information from the OEM

FRONT COVER

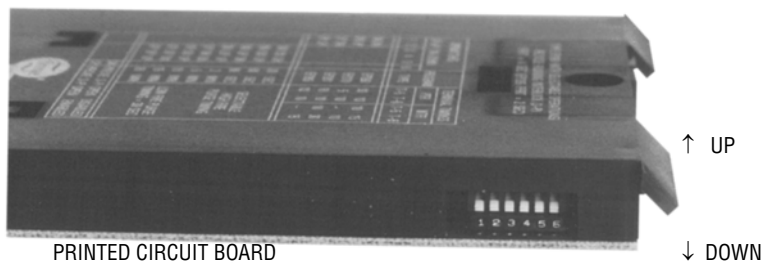

DIPSWITCH 1 - RECYCLE OR NON-RECYCLE OPERATION:

Dipswitch 1 determines if the programmer will recycle (dipswitch 1 is Down) or lockout (dipswitch 1 is Up) when the running interlock circuit (3-P) is opened during the firing cycle. The programmer is shipped with the switch down (recycle operation).

DIPSWITCH 2 - INTERMITTENT OR INTERRUPTED OPERATION OF TERMINAL 6

Dipswitch 2 selects either intermittent or interrupted operation of terminal 6. When terminal 6 is selected for intermittent operation (dipswitch 2 in Down position), terminal 6 remains energized throughout the firing period. When terminal 6 is selected for interrupted operation (dipswitch 2 in Up position), terminal 6 is energized for 10 seconds during PTFI and 15 seconds during MTFI before de-energizing. The programmer is shipped with the switch down (intermittent operation).

DIPSWITCHES 3, 4, and 5 - EXTENDED PURGE TIMING

The EP300 series programmers have the following purge timings: EP380 (30 seconds), EP381 (15 seconds), EP382 (1 second), and EP390 (90 seconds). The purge timing is initiated after the burner/blower motor is energized. Dipswitches 3, 4 and 5 can **increase** the purge timing of the programmer module. The dipswitches can not shorten the purge timing of a programmer. For example, the purge timing of the EP380 (30 second purge) cannot be set to 5 seconds. To extend the purge timing of an EP380 to 5 minutes, set dipswitches 3, 4 and 5 as follows:

3 4 5
Up Up Down = 5 minute purge



Dipswitches 3, 4 and 5 are set by the factory in the Down position and are inactive until the settings increase the purge timing of the programmer module. Position the dipswitches to the desired setting to increase the purge timing of the programmer.

DIPSWITCH 6 - 3-P RUNNING INTERLOCK CIRCUIT PROVEN OPEN TO START

Dipswitch 6 provides the option that requires the 3-P running interlock circuit to be proven open at the start of the operating cycle. If this option is enabled (switch 6 is Up), the 3-P running interlock circuit is required to be open at the start of the operating cycle (L1-13 circuit closed). If this option is enabled and the 3-P circuit is closed at the start of the operating cycle, the control will hold for one (1) minute waiting for the 3-P circuit to open. If after one (1) minute, the 3-P circuit does not open, the control will lockout. The programmer is shipped with this option disabled (switch 6 is Down).

Refer to the following for an overview of all of the dipswitch settings.

DIPSWITCH POSITION ¹						FUNCTION
U = UP		DN = DOWN				
1	2	3	4	5	6	
Dn						Recycle on 3-P Open
Up						Non Recycle on 3-P Open
Dn						Intermittent
Up						Interrupted
		Dn	Dn	Dn		1 sec.— EP382
		Dn	Dn	Up		5 sec.
		Dn	Up	Dn		15 sec.— EP381
		Dn	Up	Up		30 sec.— EP380
		Up	Dn	Dn		90 sec.— EP390
		Up	Dn	Up		2 min.
		Up	Up	Dn		5 min.
		Up	Up	Up		10 min.
					Dn	Prove 3-P Open DISABLED
					Up	Prove 3-P Open ENABLED

¹ The dipswitches are inactive on the EP383 programmer.

PROGRAMMER AND DISPLAY MODULE COMPATIBILITY

Two display modules are available for the FLAME-MONITOR control system (P/N's ED500 and ED510). The ED500 is an 8 character LED display that physically mounts in the card rack of the EB700 chassis. The ED510 is a 2 line by 16 character LCD with keypad to provide both current and historical information pertaining to the operation of the control. Refer to Bulletin ED-5101 for a complete description of the features and capabilities of the ED510 display module. The EP300 series programmers with an Engineering code of 28 or later (e.g. 9414-28) are compatible with both the ED510 and ED500 display module. Programmers with an Engineering code before 28 are only compatible with the ED500 display. The ED510 display physically mounts onto the front cover of the EP programmer (Engineering code 28 or later). The ED510 display is required for initial configuration of the EP383 programmer.



IMPORTANT INFORMATION — PLEASE READ CAREFULLY

PERMANENT BURN-IN OF DIPSWITCH FUNCTIONS

The EP Programmer modules have a set of six (6) dipswitches on the side of the programmer to modify various functions associated with the operation of the programmer (e.g. purge timing, prove 3-P circuit open to start, etc.). **THESE FUNCTIONS BECOME PERMANENT AFTER THE CONTROL HAS BEEN POWERED FOR EIGHT (8) HOURS.**¹ After this burn-in period, changing position of the dipswitches will not change the operation of the programmer.

The user can bypass the burn-in period via the ED510 display module. Use the SCROLL and MODE key to select the “Programmer Set-Up” Sub-Menu (Refer to bulletin ED-5101) and then the SCROLL key to display the prompt:

**PRESS RESET TO
ACCEPT SETTINGS**

Press the Reset key at this prompt and the screen will display:

**YOU AGREED TO
ACCEPT SETTINGS**

After the above key sequence is completed, changing the position of the dipswitches will not change the operation of the programmer.

PROGRAMMING THE EP383 PROGRAMMER

The EP383 Programmer Module provides a number of operational characteristics that are selected via the ED510 Keypad/Display. The following are a list of the programmable functions associated with the EP383 Programmer Module:

- Selectable flame failure response time (2 or 4 seconds)
- Selectable purge (selectable from 1 second to 30 minutes - default setting is 30 seconds).
- Prove the operation of the Running Interlock Circuit (3-P).
- Selectable timings on terminals 5 and 6 during Pilot Trial For Ignition (PTFI).
- Selectable recycle or non-recycle operation of the running interlock circuit (3-P).
- Intermittent or interrupted operation of terminal 6.
- Selectable operation to delay energizing terminal 5 during Pilot Trial For Ignition (PTFI).
- Selectable Count Up or Count Down operation during purge.
- Selectable Post Purge Timing of 1 or 15 seconds.

NOTE: Dipswitches on the side of the EP383 Programmer DO NOT provide any function. The ED510 Display Module is used to select the programmable functions.

MODIFYING THE EP383 PROGRAMMER

1. Insert the EP383 programmer module into the EB700 chassis and connect the ED510 Keypad/ Display.
2. Open the operating control (L1-13) circuit. The EP383 **cannot be modified** unless the operating control is open.
3. The **PROGRAM SETUP** sub-menu will be used to display the programmable functions. Press the **SCRL** key until the PROGRAM SETUP sub-menu is displayed.
4. Press the **MODE** key to enter the **PROGRAM SETUP** sub-menu. The **SCRL** key will advance through the selections in the sub-menu. The first four items displayed in the sub-menu are **PROGRAMMER TYPE EP383, ENGR CODE, and AMPLIFIER TYPE**. These items are not programmable.

¹ Programmer module EP383 has a fifty (50) hour burn-in period.



5. Press the **SCRL** key and the next item displayed (and first programmable item) is **FLAME FAIL TIME** followed by the current setting (default setting = 4 seconds). The selectable flame failure response times are 4 and 2 seconds. Default is 4 seconds.
6. Press the **RESET** button to enter the “Modify” mode (providing the control was not in a lockout condition). The control will display **SCRL TO MODIFY** on the top line of the display (replacing **STANDBY**).
7. Press the **SCRL** key to advance through the allowable selections. The selections will roll around from the last selection to the first one.
8. Press the **RESET** key to choose and store in memory the appropriate selection.
9. The **SCRL** key will advance through the following selections. Follow steps 6 through 8 to modify the selections.
10. **PURGE TIME** 0:30 Available selections are 0:01, 0:15, 0:30, 1:00, 1:30, 2:00, 5:00, 10:00, 15:00, and 30:00. 30 seconds (00:30) is the default selection.
11. **PROVE 3-P OPEN N**. Available selections are Yes (Y) and No (N). If selected Y, at the start of the operating cycle, the control will check to see if the 3-P circuit is open before energizing the blower motor. If closed, the control will hold for 60 seconds and then lockout. No is the default selection.
12. **PTFI TIMING 15 SEC**. This selects the timings for terminals 5 and 6 during Pilot Trial For Ignition (PTFI). Available selections are 5, 10, 15 and 30 seconds. Timing selection applies to both terminal 5 and 6. The default selection is 15 seconds.
13. **RECYCLE 3-P = Y**. This selects whether the control will recycle (Y) or lockout (N) when the running interlock circuit (3-P) is opened during the firing cycle. The default selection is Y.
14. **TERMINAL 6 = INTMT**. This selects either intermittent or interrupted operation of terminal 6. When terminal 6 is selected for intermittent operation, terminal 6 remains energized throughout the firing period. When terminal 6 is selected for interrupted operation, terminal 6 is energized for 15 seconds for MTFI before de-energizing. The default selection is INTMT (Intermittent).
15. **IGNITION DELAY = N**. This selects whether the ignition terminal 5 is delayed for 3 seconds at the start of PTFI before being energized. If the selection is No, terminal 5 is energized at the start of PTFI. The default selection is N.
16. **PURGE COUNT UP**. This select whether the control will count UP or DOWN during purge. The default selection is COUNT UP.
17. **POST PURGE 15**. Available selections are 15 seconds and 1 second. Default value is 15 seconds.



CAUTION: Per UL 296, a mechanical draft burner having an input in excess of 20 GPH (7.6 L/H) shall provide a post-purge period of not less than 15 seconds.

18. **UNIT ADDRESS 00**. Available selections are 00 through 15. Default selection is 00.
19. **PRESS RESET TO ACCEPT SETTINGS**. Press the **RESET** key to accept the current settings (over-riding the 50 hour normal burn-in period). Otherwise, the settings will be permanently burned in after a 50 hour burn-in period. After the 50 hour burn-in (or “ACCEPTING”) period, the settings cannot be changed.
20. Press the **MODE** key to return to the run message.



WARNING: THE INAPPROPRIATE SELECTION OR APPLICATION OF A PROGRAMMER MODULE COULD RESULT IN AN UNSAFE CONDITION HAZARDOUS TO LIFE AND PROPERTY. Care should be taken to ensure the proper selection for each setting. Selection of the settings for a particular application should be made by a competent professional, such as a Boiler/Burner technician licensed by a state or government agency, engineering personnel of the burner, boiler, or furnace manufacturer (OEM), or in performance of duties based on information from the OEM.

RJ STYLE CONNECTORS

ED510 Display

Programmer modules (with Eng. code 28 or higher) include an RJ45 style connector to an alphanumeric display (P/N ED510). The ED510 can snap onto the front cover of the programmer module or be mounted remotely (See Bulletin E-8101). The ED580 cable (provided with ED510 Display) then plugs into the RJ style connectors on both the ED510 display and programmer module.

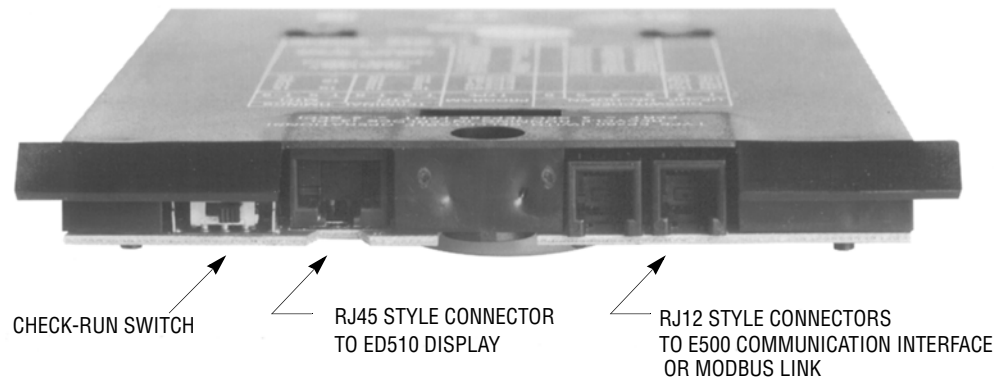

REMOTE ED510 DISPLAY CABLING

Ferrite Core for Improved Noise Immunity (for ED580 cables)

Fireye has provided an EMI/RFI ferrite core on the ED580 remote ED510 display cables to improve the noise immunity of the FLAME-MONITOR™ system. The ferrite core presents a high impedance to transients injected into the control via the ED580 remote display cable. **In order for the ferrite core to operate properly, the mounting cabinet MUST BE GROUNDED to a proper Earth Ground, and the FLAME-MONITOR wiring base MUST BE WELL BONDED to the cabinet via the three mounting screws and the green grounding screw on the wiring base.**

The ferrite core is included with the ED580 cables and remote ED510 display mounting kits (P/N 129-145), as well as being available in a separate upgrade kit (P/N 129-152). The ED580 connector closest to the ferrite core must be plugged into the EP Programmer.

To install the ferrite core (supplied with 129-152 upgrade kit) on the ED580 Cable:

1. Disconnect the ED580 cable from the EP programmer module and ED510 display module.
2. Open the ferrite core and place the ED580 cable into the center groove of the ferrite core so it is positioned approximately 12 inches from one end of the ED580 cable.
3. Loop the ED580 cable **once** around the ferrite core so the cable wraps over the cable previously placed in the center groove of the ferrite core. See diagram.
4. Snap the ferrite core closed. The ferrite core should now be approximately 5 1/2 inches from the connector.
5. Connect the ED580 cable to the EP Programmer Module and ED510 Display Module. **The connector closest to the ferrite core must be plugged into the EP Programmer.**
6. **TO ENSURE THE SYSTEM IS PROPERLY GROUNDED:**
 - Connect the back plane of the mounting cabinet to a proper earth ground.
 - Ground the FLAME-MONITOR wiring base to the mounting cabinet by using mounting screws with star washers to ensure proper electrical contact.
 - Connect the green grounding screw on the wiring base to a proper earth ground.

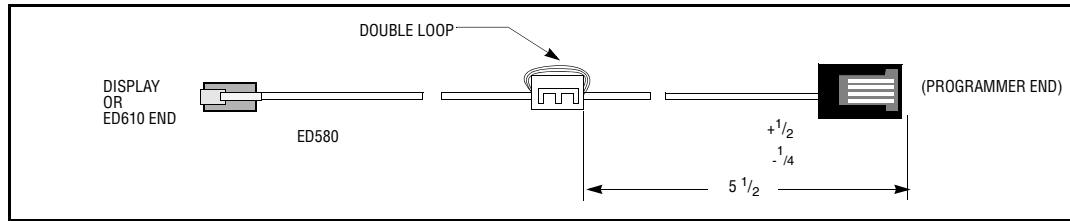

REMOTE COMMUNICATIONS CABLING VIA RS485

Ferrite Core for Improved Noise Immunity (for ED512 cables)

Fireeye has provided an EM1RF1 ferrite core on the ED512 remote communications cables to improve the noise immunity of the FLAME-MONITOR system. The ferrite core presents a high impedance to transients injected into the control via the ED512 communication cable. **In order for the ferrite core to operate properly, the mounting cabinet MUST BE GROUNDED to a proper Earth Ground, and the FLAME-MONITOR wiring base MUST BE WELL BONDED to the cabinet via the three mounting screws and the green grounding screw on the wiring base.**

The ferrite core is included with the ED512 cables as well as being available in a separate upgrade kit (P/N 129-152). **The ED512 connector closest to the ferrite core must be plugged into the EP Programmer.**

To install the ferrite core (supplied with 129-152 upgrade kit) on the ED512 cable:

1. Disconnect the ED512 cable from the EP programmer module and ED610 adaptor.
2. Open the ferrite core and place the ED5120 cable into the center groove of the ferrite core so it is positioned approximately 14 inches from one end of the ED512 cable.
3. Loop the ED512 cable twice around the ferrite core so the cable wraps over the cable previously placed in the center groove of the ferrite core. See diagram below.
4. Snap the ferrite core closed. The ferrite core should now be approximately 5 1/2 inches from the connector.
5. Connect the ED512 cable to the EP Programmer Module and ED610 Adaptor. **The connector closets to the ferrite core must be plugged into the EP Programmer.**
6. **TO ENSURE THE SYSTEM IS PROPERLY GROUNDED:**
 - Connect the back plane of the mounting cabinet to a proper Earth Ground.
 - Ground the FLAME-MONITOR wiring base to the mounting cabinet by using mounting screws with star washers to ensure proper electrical contact.
 - Connect the green grounding screw on the wiring base to a proper Earth Ground.

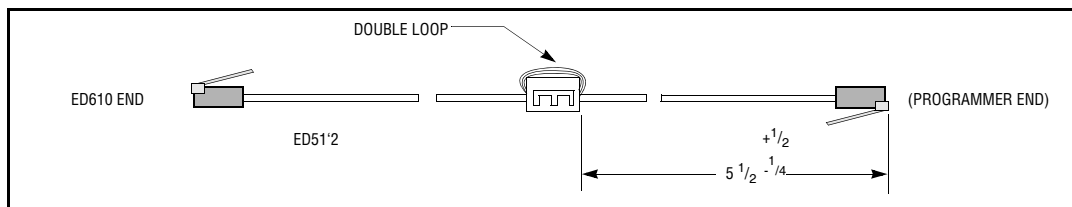

Check-Run Switch

The Check-Run switch is located on the top of the EP Programmer Module and can be used to stop the control in its firing sequence at any time except MTFI. If moved during the MTFI period, it is not functional and automatic programming continues. It aids in the set-up and adjustment of the burner linkages, pilot assembly, etc. Refer to Bulletin E-1101 for a complete description of the Check-Run Switch.



E500 Communication Interface

Programmer modules (with Engineering code 28 or later) include two (2) RJ12 style connectors to connect to the RS485 Interface on the E500 Communication Interface in a multi-drop wiring configuration with other devices. Refer to Bulletin E-5001. Up to six (6) EP programmers and E340 Boiler Controls (12 total) can be wired in a multi-drop configuration (Unit address 00 to 15). When connected in this manner to the E500, a unit address must be set on each programmer module connected to the RS485 interface. (See Unit Address). Programmers can also be connected to the E500 via the standard flat ribbon cables (ED550).

UNIT ADDRESS

There are two methods to program the unit address when the programmer module is connected to the E500 via the RS485 interface:

Method One (ED510 display only)

1. Press the SCRL key until the screen displays PROGRAM SETUP
2. Press the MODE key and the screen displays PROGRAMMER EP380 (or appropriate model).
3. Press the SCRL key until the screen displays UNIT ADDRESS #00 (or appropriate address).
4. Every time the RESET key is held down for 1 second and then released will increase the address by one.
5. Maximum address is 31. Then the address will roll over to 00.

Method Two (ED510 or ED500)

1. Make sure the control is not in a lockout condition. If so, press the reset button.
2. Open the operating control (term L1-13).
3. Move the "Check-Run" switch to the Check position.
4. The display will indicate Unit Address 00 (or the current address).
5. Every time the reset button is held down for 1 second and then released will increase the address by one.
6. Maximum address is 31. Then the address will roll over to 00.

COMMUNICATIONS – ENGINEERING CODE 38 OR HIGHER

The protocol to be used is Modbus RTU. This is implemented by the master (PC, PLC, etc.) issuing a poll to the slave (Flame-Monitor) and the slave responding with the appropriate message.

A typical format of a poll request is as follows:

DST	FNC	ADR HI	ADR LO	DAT HI	DAT LO	CRC LO	CRC HI
-----	-----	-----------	-----------	-----------	-----------	-----------	-----------

DST refers to the logical address of the slave.

FNC is the function being requested. FNC 03 is a read request.

ADR is the message number or register number of the data being requested. In Modbus, register addresses begin at 40001 but is interpreted as address 00.

DAT is the number of words being requested. A word is an integer consisting of 2 bytes.

The normal response from a slave is as follows:

DST	FNC	DBC	DATA.... HI/LO	CRC LO	CRC HI
-----	-----	-----	-------------------	-----------	-----------

DBC is the data byte count being returned. It must be two times the DAT number from the poll request.



DATA is the data returned and is always a series of 2 byte integers. If 4 words were requested then DBC would be 8 and there would be 8 data bytes or 4 data words containing the requested data.

The format of the data is 4800,N,8,1 meaning 4800 baud, no parity, and 1 stop bit.

Below is a table of currently available messages provided by the Flame-Monitor programmers, followed by a description where necessary.

Table 1:

MESSAGE ADDRESS	WORD REQUESTED	RESPONSE	VALUE
00	1-6	STATUS	83 (053H) = RUN; 202 (0CAH) = LOCKOUT
01	1	MSGN	Current message being displayed (see Table 3)
02	1	GSTAT	Defines Timer Type
03	1	TIMER	Time, Flame, Address
04	1	FLAME	Flame Signal
05	1-3	LOGSTAT	Current logic module, PURGE, PTFI, AUTO (see Table 2)
06	1	INPUTS	Input limits state
07	1	OUTPUTS	Output relays state
08	2	SYSMINS	System on minutes
10	2	BNRMINS	Burner on minutes
12	2	CYCLES	Completed Burner Cycles
14	1	LOCKOUT COUNT	Stored Lockout Count
15	1-6	LOCKOUT HISTORY	Last 6 Lockouts, first word is most current lockout
21	1-2	DEV TYP	Programmer device type, 5=EP, 6=EPD, 7=MicroM
22	1	AMPTYP	Amplifier Type; EUVS4=0C0H; EIR1=0A0H; ERT1, EUV1=090H;

Message 00 and message 05 are unique in that a limited number of successive registers can be combined with these requests. For example, a request to message 00 can contain up to 6 data words. The response to this would contain STATUS, MSGN, GSTAT, TIMER, FLAME and LOGSTAT. If the requested data word count (DAT) were to be 2 then the response would contain STATUS and MSGN only.

The MSGN being transmitted is a numerical value and must be interpreted by the communicating device, which actually is an advantage since this can be made to be whatever message text the end user wants. In other words, it allows for programming custom messages without actually changing the message in the programmer. Refer to Table 3 for message information.

The Flame-Monitor stores its burner on time and system on time (L1 powered) in minutes. The programmer normally converts this to hours for display purposes. The information being supplied by Modbus will be the actual time in minutes and it is up to the communicating device to do the conversion. Since the maximum value stored in the Flame-Monitor is 9,999,999 minutes, the maximum value in hex therefore is 98967FH and comprises two data words. The maximum cycle count is 999,999 decimal or F423FH, still two data words.

All values are represented in a HEX or base 16 format.

GSTAT determines the type of value TIMER represents. TIMER can be a running timer such as is used in purge, a flame signal or meaningless. Only the lower nibble of GSTAT has any value. If this value is 0 then the TIMER value has no meaning. The value in TIMER is a background minute timer in the Flame-Monitor and should be ignored. If GSTAT is between 4 and 7, the TIMER represents the current value flame signal. If GSTAT is a 1, 2, or 3 then TIMER represents a running timer value.



The baud rate of the Flame-Monitor is fixed at 4800 bits per second. The format of the data is 8 data bits, no parity and 1 stop bit. Due to the RS485 format, the communication format is considered half-duplex. That is, only one user is permitted on the communication lines at a time.

The information contained in INPUTS and OUTPUTS represents the status of the interlocks and relays respectively. For the INPUTS, a 1 in the interlock position defines the interlock as being on or energize where the 1 in any bit position in the OUTPUT register signifies the relay as being energized.

Refer to Fireye bulletin E-1101 for terminal designations.

INPUTS

Term P	Term 5/6	Term D		Term 8	Term 7	Term 3	Term 13
Air Flow	Ignition	Low Fire	Ref	High Fire	Main Fuel	FVES or POC	Op Ctrl

A '1' in the opto-coupler position indicates the opto-coupler is on or interlock closed.

OUTPUTS

Term 11	Term M	Term 6		Term 5	Term 7	Term A	Term X
Auto (RA1)	Blower (RB)	Ignition (RA2)	FVES (RV)	Pilot (RP)	Main Fuel (RF)	Alarm (RL)	High Fire (RH)

LOGSTAT is an indication of what logic module the control is currently in during its operating sequence and is used for diagnostic purposes only. The message displayed corresponds to the current logic module. The range of values are 4FH for Standby, 47H for Post Idle through 4DH for Shutdown2.

It is suggested that repeated polling interval not be less than 200 mSec per request. Requesting data such as burner minutes, system minutes and burner cycles should be kept at a minimum due to the amount of processing time required to gather that data.

Table 2:

EXPLANATION OF LOGSTAT

LOGIC DISPATCHER	
VALUE	FLAME-MONITOR
(hex)	
45H	MPOSTIDLE
46H	MPREPURGE1
47H	MPURGE
48H	MPOSTPURGE
49H	MTFI
4AH	MTFMF
4BH	MAUTO
4CH	MSHTDWN1
4DH	MSHTDWN2
4EH	MIDLE

Logstat represents the current software module the Flame-Monitor is currently executing. They are named as close to the logic module the actual burner sequence is in. For instance, in the Flame-Monitor, MPURGE represents High Fire Purge where MPOSTPURGE represents low fire start purge. MSHTDWN1 represents the post purge period after a complete cycle or the cool down period after a lockout.

MIDLE or STANDBY is the period of time where the operating control is open or the control is in lockout waiting for reset. On instances of false flame during the purge period, the control algorithm forces the control back to STANDBY until false flame ceases or lockout occurs.



MPREPURGE1 is the period of time prior to PURGE where the control checks the status of the air flow interlocks or in the case of the Flame-Monitor, high fire proving switch (D-8). If found open, the control will remain in this state until the respective switch closes or lockout occurs.

MTFI represents the pilot ignition stage of a burner sequence. MTFMF represents the main trial for ignition period where main fuel is introduced along with pilot.

MAUTO is the run period of the burner sequence.

MPOSTIDLE and MSHTDWN2 are small periods of time where certain internal tests are conducted and general cleanup before and after a cycle is performed.

Table 3:

DEC	HEX	FLAME-MONITOR
1	1	L1-13 OPEN
2	2	FALSE FLAME
3	3	LOW FIRE PURGE
4	4	D-8 LIMIT OPEN
5	5	3-P AIR FLOW OPEN
6	6	LINE FREQUENCY NOISE DETECTED
7	7	FLAME FAIL
8	8	UNIT ADDRESS
9	9	M-D LIMIT OPEN
10	A	IGNITION TIMING
11	B	MTFI
12	C	FLAME SIGNAL
13	D	CYCLE COMPLETE
14	E	L1-13 OPEN
15	F	AC POWER FAIL (COEN)
16	10	SHORT CIRCUIT TERMINAL 5,6 or 7
17	11	D-8 LIMIT OPEN
18	12	M-D LIMIT OPEN
19	13	FLAME FAIL - MTFI
20	14	FALSE FLAME
21	15	3-P INTLK OPEN (PURGE)
22	16	3-P INTLK CLOSED
23	17	3-P INTLK CLOSED
24	18	HIGH FIRE PURGE
25	19	PLEASE WAIT
26	1A	3-P INTLK OPEN
27	1B	3-P INTLK OPEN (MTFI)
28	1C	3-p INTLK OPEN (PTFI)
29	1D	13-3 FVES OPEN
30	1E	FALSE FLAME (PURGE)
31	1F	FLAME SIGNAL
32	20	D-8 HI LIMIT (CHECK)
33	21	M-D low LIMIT (CHECK)
34	22	FLAME SIGNAL
35	23	LOW FIRE SIGNAL (CHECK)
36	24	FLAME SIGNAL
37	25	FLAME FAIL (AUTO)
38	26	3-P INTLK OPEN
39	27	FUEL VALVE STATE CHANGE



DEC	HEX	FLAME-MONITOR
		E300 EXPANSION MODULE MESSAGES
40	28	3-P AIR FLOW OPEN (28H)
41	29	3-P high water
42	2A	3-P low water
43	2B	3-P high gas pressure
44	2C	3-P low gas pressure
45	2D	3-P low oil pressure
46	2E	3-P low oil temperature
47	2F	3-P low atomizing media
48	30	3-P high steam pressure (30H)
49	31	3-P high temperature
50	32	3-P aux #4 open
51	33	3-P aux #5 open
52	34	3-P aux #6 open
53	35	3-P fuel select
54	36	CHECK CHASSIS
55	37	CHECK PROGRAMMER
56	38	CHECK AMPLIFIER
57	39	CHECK EXPANSION MODULE
58	3A	AMPLIFIER AUTO CHECK FAIL
59	3B	SCANNER NOISE
60	3C	L1-13 AUX #1 OPEN TERMINAL 20
61	3D	L1-13 AUX #2 OPEN TERMINAL 21
62	3E	L1-13 AUX #3 OPEN TERMINAL 22
63	3F	3-P HIGH WATER TERMINAL 23
64	40	3-P LOW WATER TERMINAL 24
65	41	3-P HIGH GAS PRESSURE
66	42	3-P LOW GAS PRESSURE
67	43	3-P LOW OIL PRESSURE
68	44	3-P LOW OIL TEMPERATURE
69	45	3-P LOW ATOMIZING MEDIA
70	46	3-P HIGH PRESSURE TERMINAL 31
71	47	3-P HIGH TEMPERATURE TERMINAL 32
72	48	3-P AUX #4 OPEN TERMINAL 33
73	49	3-P AUX #5 OPEN TERMINAL 34
74	4A	3-P AUX #6 OPEN TERMINAL 35
75	4B	3-P FUEL SELECT
76	4C	CHECK SCANNER
77	4D	HOLD D-8 LIMIT CLOSED
78	4E	LOCKOUT D-8 LIMIT CLOSED
79	4F	HOLD M-D LIMIT CLOSED
80	50	LOCKOUT M-D LIMIT CLOSED
81	51	LOCKOUT 13-3 POC CLOSED
82	52	DYNAMIC CHECK^

RESETTING THE PROGRAMMER'S "HISTORY"

Code 35 (or higher) programmers (identified as a suffix to the programmer's production on date code, e.g. 9650-35) allow the user to reset the programmer's history to zero via the ED510 display. This will reset the "burner cycles," "burner hours," and "system hours" count to zero. It will also erase the "lockout history" (the last six lockout messages).

To reset the programmer's history to zero:

1. Open the operating control.
2. Press the SCRL key until the ED510 screen displays SYSTEM INFO.
3. Press the MODE key and the screen displays AVG PILOT FLM 22.
4. Press the SCRL key until the screen displays:
PRESS RESET TO
CLEAR HISTORY
5. Press the RESET key to reset burner cycles, burner lockouts, system hours, and lockout history to zero.

Note: The control cannot be in a lockout condition to clear the programmer's history. Otherwise, pressing the reset key will only reset the lockout.

OPERATION

The dipswitch settings on the EP380, EP381, EP382, and EP390 programmer module determine several functions of the FLAME-MONITOR control (e.g. Recycle or non-recycle operation on running interlock circuit, intermittent or interrupted operation of terminal 6, extended purge timing, and either enable or disable the 3-P Proven Open To Start function). The programmer module also provides the operator with a constant status indication as well as diagnostic information. A programmer with an Engineering code of 28 or later (e.g. 9414-28) is compatible with either the ED510 (2 line x 16 character LCD display with keypad for local access to historical information) or ED500 (8 character LED display). For purposes of illustration for this bulletin, we will be looking at the EP380 Programmer functions (recycle operation on 3-P, intermittent operation of terminal 6) and messages associated with the ED510 display module. The ED500 display messages will be abbreviated versions of those of the ED510. Refer to the suggestions shown in this bulletin before proceeding to power the Fireye E110 FLAME-MONITOR system. Items such as scanner installation, short circuit tests and safety information should be reviewed.



CAUTION: On initial power-up and on restarts following a power failure, the control will perform self-test diagnostics for 15 seconds.

Start-Up (Normal Cycle)

NOTE: For direct spark ignited oil burners, substitute the words Main-oil Valve for Pilot Valve.

1. Constant 120 VAC should be connected to the L1-L2 terminals on the wiring base.
2. The operating control circuits (L1-13) will close, signaling the burner to start its firing sequence.
3. Assuming the fuel valve end switch (13-3) is closed, the burner/blower motor (terminal M) circuit is energized. The running interlock (limit) circuit (3-P) will close (e.g. all limits, interlocks, etc. are proven).
4. The prepurge interval of 30¹ seconds is initiated. The ED510 will display:
PURGE 00:05
5. When the prepurge is completed, the control will wait for the low fire switch (M-D) to close. When it closes, the trial for ignition sequence will start. If after ten minutes, the M-D circuit is not closed, the control will lockout.

¹. Purge timing can be increased via dipswitches.



- The trial for ignition period begins with Terminals X¹, 5 and 6 being energized simultaneously. This is known as PTFI (Pilot Trial for Ignition). PTFI is 10 seconds in duration. The ED510 will display:

PTFI 00:02
IGNITION TIMING

- Five seconds after being energized, terminal X² is de-energized.
- Terminals 5 and 6 remain energized during the 10 second PTFI period. If no flame is detected after ten seconds, the control will de-energize Terminals 5 and 6 and lockout. When flame is detected during this 10 second period, the ED510 will display:

PTFI 20²
FLAME SIGNAL

- With flame proven at the end of PTFI, the main flame trial for ignition (MTFI) period begins. Terminal 7 is energized. The ED510 will display:

MTFI 35³
FLAME SIGNAL

Terminal 5 is de-energized 10 seconds later. Terminal 6 remains energized all during the firing period.³

- During the remainder of the firing period, the ED510 will display:

AUTO 40³
FLAME SIGNAL

Normal Shutdown

- When the operating control circuit (L 1-13) opens, the main fuel valves are de-energized (terminals 6 and 7).
- Following a 15 second post purge, the burner/blower motor is de-energized.
- The burner is now off and the ED510 will display

STANDBY
L1-13 OPEN

ED510 BACKLIT DISPLAY

With current ED510's (Engineering Code 3 or higher), the LED display backlight remains ON at all times. With earlier ED510 versions, the backlight will be lit when the L1-13 (operating control) circuit is closed, and OFF when the L1-13 circuit is open. With the earlier displays, depressing any key will light the display for three (3) minutes.

LOCKOUTS

When a safety shutdown occurs, the control will display a message indicating LOCKOUT and the reason for the lockout. The alarm circuit (Terminal "A") will be energized. The non-volatile memory will remember the status of the control even if a power failure occurs. By depressing the reset button on the display, the control can be reset. The button must be held down for one second and then released. Very little force is required to do this. Do not press hard.

Safety Shutdown

- If dipswitch #1 is in the "Down" position (recycle operation) and the running interlock circuit (3-P) has not closed after a ten (10) minute "Hold" period during prepurge, the control will lockout and the blower motor will be de-energized. If the interlock circuit opens during the trial for

¹. The use of terminal X as an ignition terminal requires placing a jumper between terminals 5 and 10 on the wiring base.

². Or actual flame signal strength.

³. Dipswitch 2 can select terminal 6 for interrupted operation.



ignition period or firing period, all fuel valves will be de-energized and the control will initiate a 15 second post purge **and then recycle**.

2. If dipswitch #1 is in the “Up” position (non-recycle), and the running interlock circuit (3/P) has not closed after ten (10) seconds into purge, the control will Hold for ten (10) minutes and then lockout. If the 3/P circuit has closed, and then opens after ten (10) seconds into purge, the control will lockout.
3. If the low fire start circuit (M-D) has not closed after a ten (10) minute “Hold” period, the control will lockout.
4. If dipswitch 6 is in the “Up” position (3-P prove open to start-enabled), and the 3-P circuit is closed at the start of the operating cycle, the control will hold for one minute waiting for the 3-P circuit to open. If, after one (1) minute, the 3-P circuit does not open, the control will lockout.
5. If pilot flame is not detected during the 10 second trial for ignition period, the pilot valve and ignition transformer will be de-energized and the control will lockout on safety.
6. If main flame is not detected at the end of the main flame trial for ignition period, all fuel valves will be de-energized and the control will lockout on safety.
7. If the main flame fails during a firing cycle, all fuel valves will be de-energized within 4 seconds after loss of flame signal and the control will lockout on safety.
8. If flame is detected when the operating control (L1-13) is open, the control will wait sixty (60) seconds and then lockout if flame is still present. If the operating control closes and flame is detected during purge, the blower motor (term M) remains energized and the purge sequence is put on hold. If the flame signal goes away within sixty (60) seconds, the control will proceed with a normal start-up. If flame signal is still present after sixty (60) seconds, the control will lockout.

***NOTE:** Manual Reset is required following any safety shutdown.*

***NOTE:** Depressing and resetting the reset button during a cycle will cause the control to shut the burner down and recycle.*

Lockout Messages

Refer to bulletins ED-5101 or E-1101 for a complete list of all messages associated with the ED510 display.

Lockout History

Lockout history and burner history can be displayed via the ED510 keypad and display. Refer to bulletin ED-5101 or E-1101.



TYPICAL WIRING ARRANGEMENT FOR PILOT IGNITED BURNERS USING EP380, EP381, EP382, EP383 OR EP390

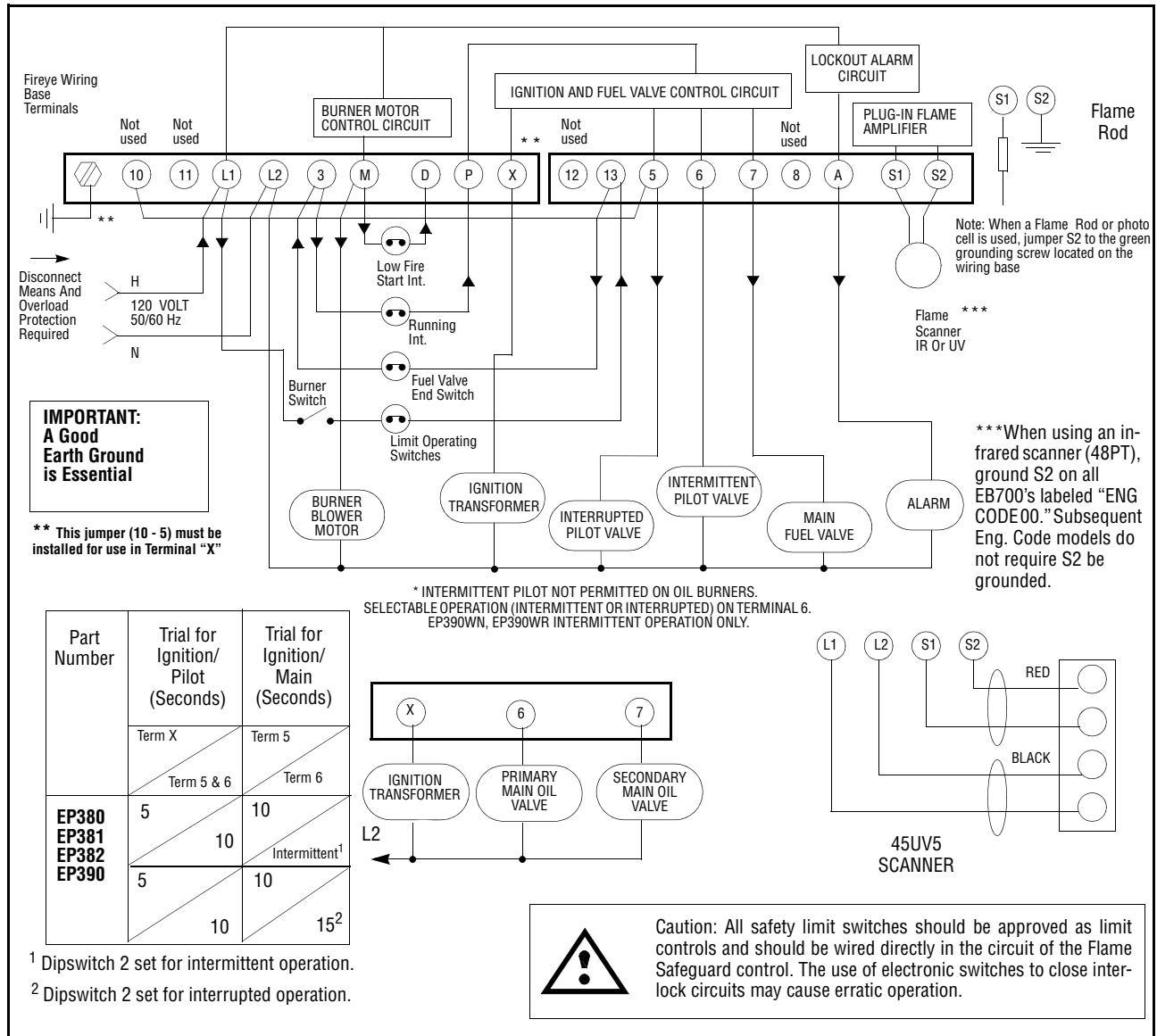

FLAME MONITOR ELECTRICAL NOISE

In applications which appear to have excessive electrical noise, it may be helpful to add an electrical noise suppressor to the power supply of the control circuit.

AUXILIARY DEVICE IN M-D-8 CIRCUIT AT FLAME MONITOR CONTROL

The function of the low fire start interlock circuit internally in a new Fireye Flame Monitor unit is accomplished by highly reliable solid state electronic circuitry. This prohibits the connection of power consuming devices (i.e. lamps, annunciators, relays, timers, etc.) to the D or 8 terminals.



NOTICE

When Fireeye products are combined with equipment manufactured by others and/or integrated into systems designed or manufactured by others, the Fireeye warranty, as stated in its General Terms and Conditions of Sale, pertains only to the Fireeye products and not to any other equipment or to the combined system or its overall performance.

WARRANTIES

FIREYE guarantees for *one year from the date of installation or 18 months from date of manufacture* of its products to replace, or, at its option, to repair any product or part thereof (except lamps, electronic tubes and photocells) which is found defective in material or workmanship or which otherwise fails to conform to the description of the product on the face of its sales order. **THE FOREGOING IS IN LIEU OF ALL OTHER WARRANTIES AND FIREYE MAKES NO WARRANTY OF MERCHANTABILITY OR ANY OTHER WARRANTY, EXPRESS OR IMPLIED.** Except as specifically stated in these general terms and conditions of sale, remedies with respect to any product or part number manufactured or sold by Fireeye shall be limited exclusively to the right to replacement or repair as above provided. In no event shall Fireeye be liable for consequential or special damages of any nature that may arise in connection with such product or part.



FIREYE®
3 Manchester Road
Derry, New Hampshire 03038 USA
www.fireeye.com

EP-3801
APRIL 4, 2013
Supersedes February 19, 2009